

# EURO PROFILE CYLINDER

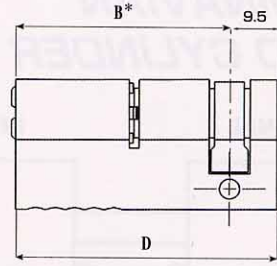
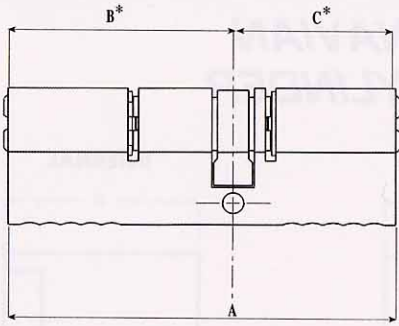

\*Using standard plugs and additional spacers in order to get to the required length

## Double Cylinder

A	62	66	70	71	75	76	80	85	90	95	100	105	110	115	120
B	31	33	35	33	35	33	35	35	35	35	35	35	40*	45*	50*
C	31	33	35	38	40*	43*	45*	50*	55*	60*	65*	70*	70*	70*	70*

## Single Cylinder

B	33	35	40*	45*	50*	55*	60*	65*	70*
D	42.5	44.5	49.5	54.5	59.5	64.5	69.5	74.5	79.5

# OVAL CYLINDER

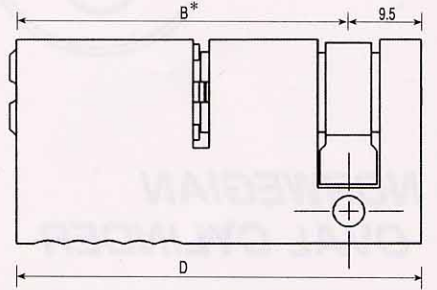
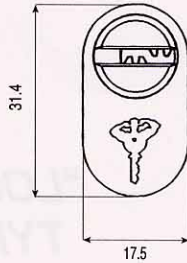
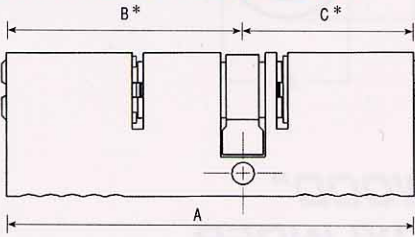

\*Using standard plugs and additional spacers in order to get to the required length

\*Using standard plugs and additional spacers in order to get to the required length

## 8 POSITION SINGLE CYLINDER

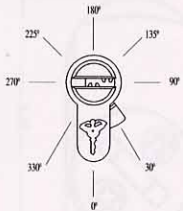

## CPGWHEELS OPTIONS

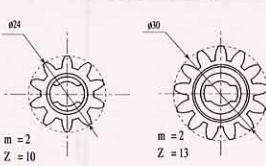

## LEVER OPTIONS

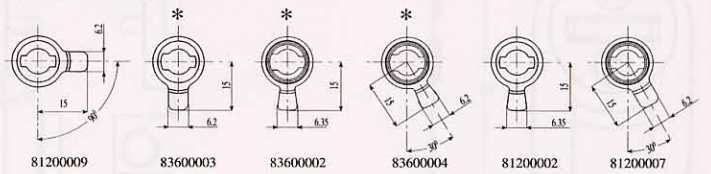

## LEVER OPTIONS

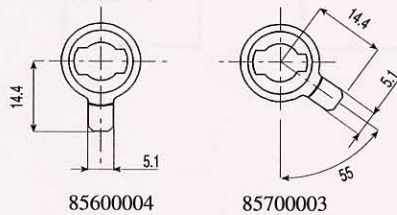

## EURP / OVAL 共通 TUMBTURNS OPTIONS

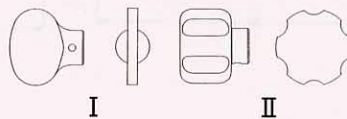

**MUL-T-LOCK®**